



# ACROBATIC SPORTS CATALOGUE

**GYMNOVA**

A passion for Gymnastics

**OVER 40 YEARS OF EXISTENCE  
A PASSION FOR ACROBATIC SPORTS**

Specializing in the design, manufacture and distribution of equipment dedicated to acrobatic sports, **GYMNOVA** is continuously innovating and plays a part in the progress of the various disciplines in this sport.



**GYMNOVA** is an international company. Our products are distributed throughout the world, via our distributor network and our subsidiaries.

**GYMNOVA means**

- Over 40 years' know-how and experience
- Working closely with coaches and gymnasts
- An untiring passion for the discipline



**SUMMARY**

<b>1- LARGE TRAMPOLINES</b>	<b>4</b>	<b>5- LONG TRAMPOLINES</b>	<b>21</b>
Large competition trampolines			
Large training trampolines		<b>6- TUMBLING TRACK</b>	<b>22</b>
Safety end decks and mats			
Accessories		<b>7- INFLATABLE TRACKS</b>	<b>24</b>
<b>2- DOUBLE MINITRAMP</b>	<b>13</b>		
<b>3- SAFETY AREA</b>	<b>14</b>	<b>8- ACCESSORIES</b>	<b>25</b>
<b>4- TRAINING TRAMPOLINES</b>	<b>15</b>		
Built-in trampolines			
Initiation trampoline			
Team Gym trampettes			
Trampettes			

**SATISFY OUR CUSTOMERS  
IS THE SOURCE OF ALL OUR COMMITMENTS**

Listening to the needs and concerns of our customers is always at the heart of our business strategy. A significant number of our employees come from the world of gymnastics, which makes us both closer to our customers, and able to understand their new and evolving expectations.

**GYMNOVA** surrounded by an experienced team to develop innovative high performance products that are continuously renewed in order to comply with the requirements and expectations

of the FIG. All our products are guaranteed in terms of safety, durability and ease of use standards.

Almost 500 **GYMNOVA** products have been developed in close collaboration with gymnastics professionals. Our engineering team has its own laboratory to carry out mechanical, static and dynamic tests and controls internally.





## LARGE COMPETITION TRAMPOLINES



### COMPETITION TRAMPOLINES

#### ULTIMATE



**FIG Approved and acclaimed by the best trampolinists in the world, the ULTIMATE trampoline with 4x4 bed will equip the next Olympic Games in Tokyo as well as the World Championships in Baku in 2021.**

This new model offers excellent control to trampolinists thanks to stabilized jumping properties and a uniform distribution of forces. Its bed makes it possible to achieve and maintain quality jumps with a markedly reduced deployment of forces.

The quality and design of the frame ensures maximum safety and stability of the trampoline when in use. And finally, «Easy-Lock-System» to set up the trampoline quicker and more efficiently by only one person.

Available in several versions, all trampolines are delivered with a transport trolley as well as a service bag (Ref. E31004).

#### AVAILABLE MODELS

PADDING	TRANSPORT TROLLEY	REF. TRAMPOLINE 4 x 4 mm BED	REF. TRAMPOLINE 5 x 4 mm BED	REF. TRAMPOLINE 6 x 4 mm BED
32 mm	Roller stands	<b>03000</b>	<b>03005</b>	-
32 mm	Lifting roller stands	<b>03100</b>	<b>03105</b>	-
32 mm	Lifting roller stands Safe & Comfort	<b>03200</b>	<b>03205</b>	-
50 mm	Roller stands	<b>03050</b>	<b>03055</b>	<b>03056</b>
50 mm	Lifting roller stands	<b>03150</b>	<b>03155</b>	<b>03156</b>
50 mm	Lifting roller stands Safe & Comfort	<b>03250</b>	<b>03255</b>	<b>03256</b>

All ULTIMATE trampolines with 4x4 bed are FIG Approved



#### TECHNICAL FEATURES

- Reinforced «electro galvanized» steel frame, section profile «egg shaped»: 520 x 305 x 115 cm,
- Bed (426 x 213 cm) attached to the frame with 110 standard springs and 8 reinforced corner springs.
- Spring padding included, 32 or 50 mm thick.
- Space on the floor (Unfolded): 520 x 305 x 115 cm (Lxwxh) ; (folded): 335 x 80 x 220 cm (Lxwxh),
- Maximum immersion depth: 1,15 m,
- Weight: 260 kg.



New design for legs section

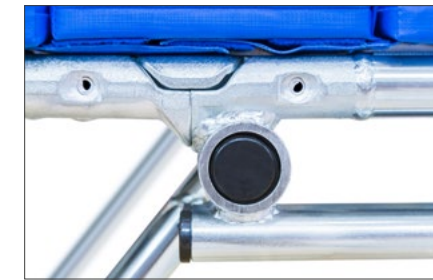

New frame design with laser cut parts giving greater potential for safety



«Easy-lock» system

#### ACCESSORIES

##### BEDS

- **REF. E26410** - ULTIMATE jumping bed 4 x 4 bedded.
- **REF. E25410** - ULTIMATE jumping bed 5 x 4 bedded.
- **REF. E26210** - Large trampoline jumping bed 6 x 4 bedded.

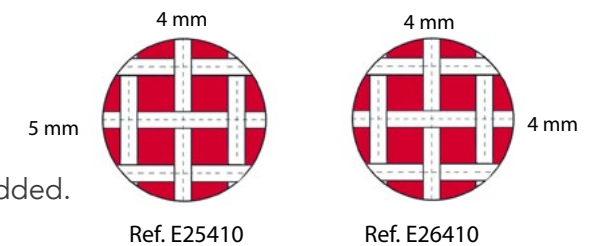

##### SPRINGS

- **REF. E31133** - Complete set of springs (110 standard springs & 8 reinforced corner springs) for ULTIMATE trampolines.



**Please see page 8 for discover safety platforms, mats and accessories**

## LARGE TRAINING TRAMPOLINES



Grand master  
with 45 x 45 mm bed

### GRAND MASTER TRAMPOLINES



#### The Ultimate versatile trampoline!

Thanks to its low height and the availability of 3 different types of beds, this model meets the needs of clubs, schools and leisure. It can also be used in the therapeutic field. The upper frame helps maintain the flexibility needed for a stabilized jump with very good swing properties.

Available in several versions, all trampolines are delivered with a transport trolley as well as a service bag (Ref. E31002).

#### TECHNICAL FEATURES

- Reinforced «electro galvanized» steel frame, section profile «egg shaped»: 520 x 305 x 108 cm,
- 426 x 213 cm bed attached to the frame with 118 tempered steel springs,
- 32 mm thick protection pads included,
- Space on the floor (Unfolded): 520 x 305 x 108 cm (LxLxh), (folded): 335 x 80 x 220 cm (Lxwxh),
- Non-slip pads,
- Maximum immersion depth: 1,08 m,
- Weight: 220 kg.

#### AVAILABLE MODELS

REF.	BEDS	PADDING	TRANSPORT TROLLEY	USE
13100	13 x 13	32 mm	Lifting roller stand	Training
13200	13 x 13	32 mm	Lifting roller stand Safe & Comfort	Training
15100	45 x 45	32 mm	Lifting roller stand	Training / Therapeutic field
15200	45 x 45	32 mm	Lifting roller stand Safe & Comfort	Training / Therapeutic field
17100	Synthetic	32 mm	Lifting roller stand	School / Leisure
17200	Synthetic	32 mm	Lifting roller stand Safe & Comfort	School / Leisure

In order to make the best use of GRAND MASTER range, it is recommended to use it in a sport hall 6 m high.

## LARGE TRAINING TRAMPOLINES



Master  
with school bed

### MASTER TRAMPOLINES



#### The ideal large trampoline for beginners!

Small in size, the MASTER model offers excellent user comfort as well as a sufficient jumping area for beginners. Its well-balanced jumping features make it especially suitable for beginners to enable a successful start in the trampolining discipline.

The Master trampoline is offered in three different jumping bed versions, which enables optimally coordinated usage in clubs, schools, leisure sports and therapy.

Available in several versions, all trampolines are delivered with a transport trolley as well as a service bag (Ref. E31002).

#### TECHNICAL FEATURES

- Reinforced «electro galvanized» steel frame, section profile «egg shaped»: 457 x 275 x 99 cm,
- 366 x 183 cm bed attached to the frame with 100 tempered steel springs,
- 32 mm thick protection pads included,
- Space on the floor (Unfolded): 457 x 275 x 99 cm (LxLxh), (folded): 304 x 70 x 198 cm (Lxwxh),
- Non-slip pads,
- Maximum immersion depth: 99 cm,
- Weight: 190 kg.

#### AVAILABLE MODELS

REF.	BEDS	PADDING	TRANSPORT TROLLEY	USE
19100	13 x 13	32 mm	Lifting roller stand	Learning
19200	13 x 13	32 mm	Lifting roller stand Safe & Comfort	Learning
21100	45 x 45	32 mm	Lifting roller stand	Learning
21200	45 x 45	32 mm	Lifting roller stand Safe & Comfort	Learning
22100	Synthetic	32 mm	Lifting roller stand	School / Leisure
22200	Synthetic	32 mm	Lifting roller stand Safe & Comfort	School / Leisure

In order to make the best use of MASTER range, it is recommended to use it in a sport hall 6 m high.





## SAFETY PLATFORMS AND MATS

Safety platforms and mats provide an optimal protection zone for the trampoline rider in the event of a fall, both in competition and in training.

### SAFETY PLATFORMS



Tubular frame in electro-galvanized steel guaranteeing maximum product life. Bed made of polypropylene fixed with bungee cords. These safety platforms are firmly fixed to the trampoline and can easily and quickly be mounted and dismantled if necessary (dismantling within 2 minutes).

-  **REF. 27300 - Safety platforms for ULTIMATE and GRAND MASTER trampolines**  
Dimensions: 262 x 187 x 115 cm - The pair.
-  **REF. 27301 - Safety platform for ULTIMATE and GRAND MASTER trampolines**  
Dimensions: 262 x 187 x 115 cm - The unit.
- REF. 27500 - Safety platforms for MASTER trampolines**  
Dimensions: 262 x 187 x 99 cm - The pair.

### SAFETY MATS





REF. 28000

**Adaptable to the range ULTIMATE, GRAND MASTER and MASTER.**

They are made of polyethylene foam (density: 24 kg / m<sup>3</sup>) and covered with a fire-resistant, tear-resistant phthalate-free PVC cover with a non-slip base. Easy to set up thanks to the carrying straps, they consist of a mats and a raised wedge connected by hook-and-loop strips (except Ref. 29000). The wedge can be removed within seconds so that the mats can also be utilised elsewhere.



REF. 28201

-  **REF. 28000 - Large trampolines safety mats**  
Dimensions: 300 x 240 cm - The pair.
-  **REF. 28001 - Large trampoline safety mat**  
Dimensions: 300 x 240 cm - The unit.
- REF. 28201 - Large trampoline safety mat with double-wedge** - Dimensions: 300 x 280 cm - The unit.  
Guarantees optimal protection when 2 trampolines are positioned side by side.
- REF. 29000 - Large trampoline safety mats with integrated wedge** - Dimensions: 300 x 200 cm - The pair.

## LARGE TRAMPOLINES ACCESSORIES

### PADDING

Protect the trampoline from the metal frame in the event of a fall. Equipped with a fixing system.

PADS THICKNESS	MASTER	GRAND MASTER & ULTIMATE
32 mm	E11120	E11110
50 mm	/	E11111

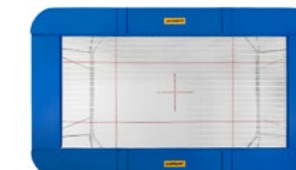

### BEDS

For more safety and durability, most of our beds are 100% bedded in nylon.

BEDS	ULTIMATE	GRAND MASTER	MASTER
4 x 4 bedded	E26410*		
5 x 4 bedded	E25410*		
6 x 4 bedded	E26210*		
6 x 6 bedded	E26310		
13 x 13		E21510	E21520
45 x 45		E21710	E21720
Synthetic		E21910	E21820

\* Compliant with FIG standards when these beds are combined with an ULTIMATE trampoline range as well as the safety platforms (Ref. 27300 or 27301) and the associated mats (Ref. 28000 or 28001).

The 45 mm bed gives a great deal of stability, is very robust and has a reduced jumping level. The high-performance 13 mm jumping bed version enables the transition to more demanding exercise types.

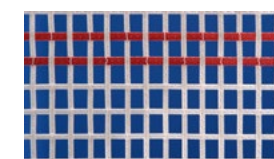

4 x 4 mm bed

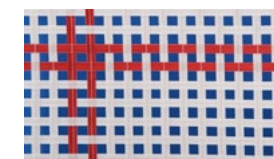

13 x 13 mm bed

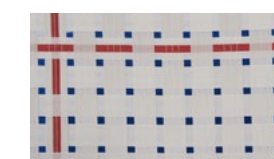

45 x 45 mm bed



Polyester bed

### SPRINGS

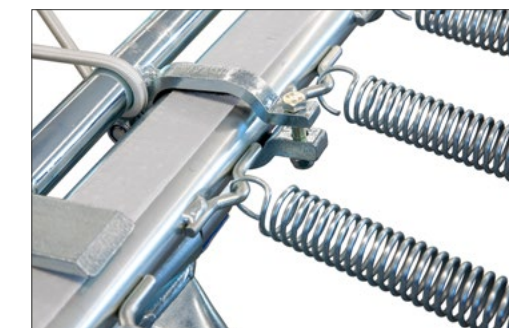

**REF. E31133** - Complete set of springs (110 standard springs & 8 reinforced corner springs)



## ACCESSORIES LARGE TRAMPOLINES

### TRANSPORT TROLLEY

In order to facilitate the transport and storage of trampolines, several trolleys are available depending on the user's needs and the constraints related to the training or competition hall.

ROLLER STAND		LIFTING ROLLER STAND		LIFTING ROLLER STAND «SAFE & COMFORT»	
					
<b>Economic version</b>		<b>Standard version</b>		<b>Premium version</b>	
Fixed height of 2.20 m		Lowering from 2,20 m to 1.97 m is possible, enabling passage through doors at room height.			
		Two-stage raising and lowering is possible		Stepless raising and lowering to the desired height is possible	
		Only suitable for experienced, trained persons		Suitable for all people Highest safety standard, easy to use and intuitive in nature	
<b>MASTER RANGE</b>	<b>GRAND MASTER &amp; ULTIMATE RANGE</b>	<b>MASTER RANGE</b>	<b>GRAND MASTER &amp; ULTIMATE RANGE</b>	<b>MASTER RANGE</b>	<b>GRAND MASTER &amp; ULTIMATE RANGE</b>
<b>Ref. E51120</b>	<b>Ref. E51110</b>	<b>Ref. E52120</b>	<b>Ref. E52112</b>	<b>Ref. E53120</b>	<b>Ref. E53110</b>

Using a standard or a «Safe & Comfort» lifting roller stand makes it possible to reduce the height of the trampoline by 23 cm and to pass through the doors without difficulty.

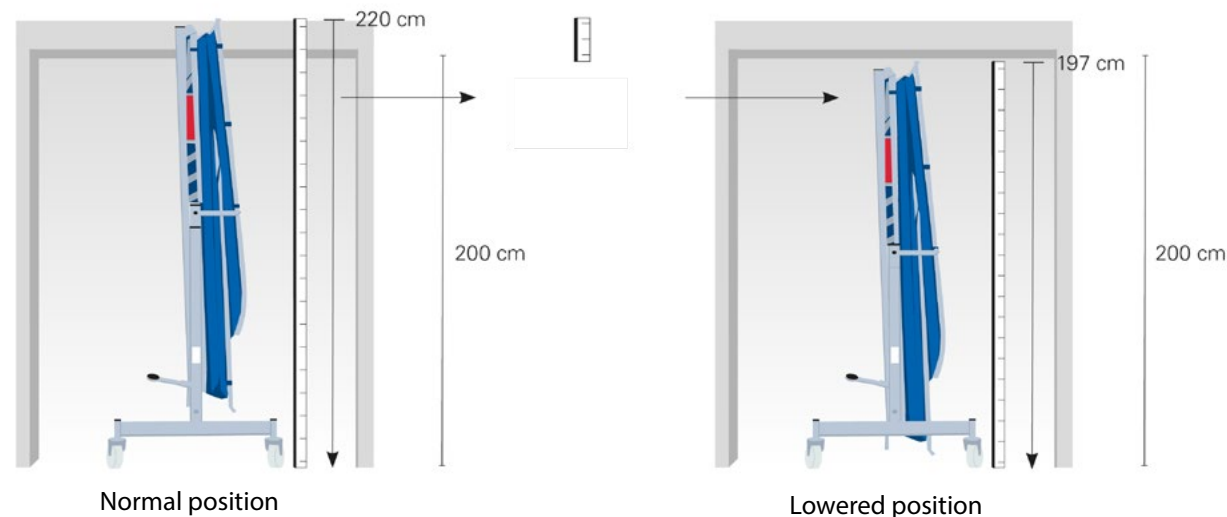

## ACCESSORIES LARGE TRAMPOLINES

### SPECIFIC TRAMPOLINE MAT

**REF. 5190**



Protection specifically designed for trampoline. Helps working on all acrobatics elements on trampoline. Reversible «spotting» mat in jersey. Leather-look underside to prevent bed wear.

Dimensions: 170 x 110 x 10 cm (FIG standards).

### SERVICE BAG

Service bag with spare parts and important documents (certificates, erection and maintenance instructions, etc.). It is guaranteed that the customer can quickly and easily exchange important components in case of wear.

This service bag contains springs, anchor bars, plastic caps and floor protection corresponding to the apparatus, etc.

This bag also includes a maintenance notebook in which the user can write down important information about their trampoline in order to get an overview of the technical condition of it.

**REF. E31002** - Service bag for MASTER & GRANDS MASTER

**REF. E31004** - Service bag for ULTIMATE

**REF. E31007** - Service bag for Double mini-trampoline





## ACCESSORIES LARGE TRAMPOLINES

### TRAMPOLINE MEASUREMENT SYSTEM

REF. HDTS01 

Measurement system for 2 trampolines. Perfect for competitions, training documentation and training regulation, the new HDTs Trampoline Measurement System offers the following measurement functions:

- ToF (Time of Flight)
- HD (Horizontal Displacement)
- SYN (Synchronicity)

Installation is quick and easy as it takes just 10 minutes.



Measurement system compatible only with ULTIMATE trampolines, for GRAND MASTER range, please consult us.

### STABILITY PLATE

To avoid these disturbing vibrations and slight displacements of the trampoline, stability plates with a slide-resistant underside are laid under the stand surface of the trampoline, which enlarges the support surface of the legs a multiple number of times. This results in higher stability and safer gymnastics.

Stability plate 50 x 50 x 3 cm made of multiple layers of limed wood with milled-recess for housing floor protection pads and slide-resistant underside.

Weight: 4 kg.

REF. TZ001 - Stability plate for GRAND MASTER and MASTER models

REF. TZ002 - Stability plate for ULTIMATE models

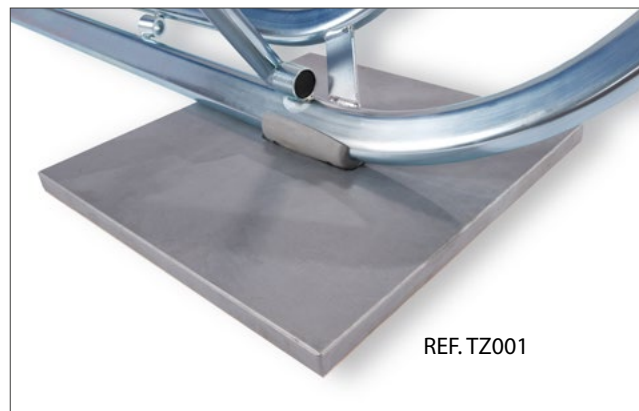

REF. TZ001

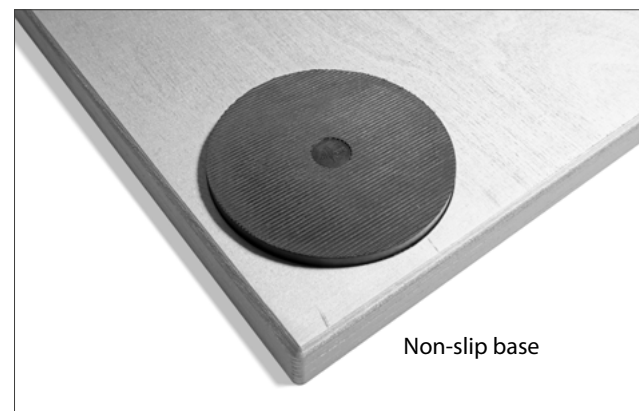

Non-slip base

## DOUBLE MINITRAMP



**EUROTRAMP**

### COMPETITION DOUBLE MINITRAMP

**ULTIMATE**



REF. 23200

**This double mini trampoline allows gymnasts to work a sequence of acrobatic moves dynamically and with confidence.**

Fitted with anti-slip pads and 32 mm thick protective padding it offers a huge degree of stability and safety. Optimization of the insertion depth in the center of the bed for better gymnast safety.

Supplied with a transport trolley as well as a service bag (Ref. E31007).

**FIG approved, this Double Mini-Trampoline has been used in numerous World Championships.**

#### TECHNICAL FEATURES

- Reinforced «electro galvanized» steel frame, dimensions: 350 x 190 x 70 cm,
- Jumping bed (292 x 92 cm) made of 6 mm wide weaved nylon bands,
- 98 steel springs (length 235 mm, Ø 28.5 mm); 4 strengthened corner springs (length 258 mm, Ø 39 mm); galvanized shock absorbing and stable frame pads
- 32 mm thick protection pads included,
- Space on the floor (Unfolded): 350 x 190 x 70 cm (Lxwxh), (folded): 215 x 70 x 197 cm (Lxwxh),
- Non-slip pads,
- Supplied with 3 protections for the feet,
- Adjustable heights from 43 à 53 cm by tensioners,
- Weight: 152 kg.

#### ACCESSORIES

REF. 23201 - Anti-slip plates  
Consisting of 2 pieces wooden panel (dim. 112,3 x 185 cm / dim.116 ,4 x 185 cm). With mounting brackets, inclusive screws.

REF. E11124 - Frame pads, Th.: 32 mm. The pair.

REF. E31123 - Set of steel springs.

REF. E21525 - Jumping bed, 6x6 mm.

REF. 2106 - Competition run-up track  
Dim.: 250 x 100 m. Th. : 25 mm.

REF. 5099 - Dedicated landing zone  
Dim.: 600 x 300 cm. Th.: 30 cm.

REF. 5098 - Dedicated over-mat  
Dim.: 400 x 200 cm. Th.: 10 cm. Optional.

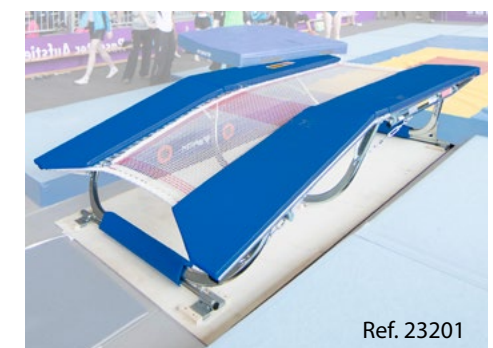

Ref. 23201



## SAFETY AREA



The landing area comprises several FIG approved mats :

- REF. 1611 - 200 x 200 x 20 cm
- REF. 1617 & 1618 - 300 x 200 x 20 cm
- REF. 1660 - Bavette enroulable, L : 1,80 m.

Made from multi-layered foam mats to provide optimum stability and safety (plateau effect guaranteed for improved weight distribution). Class M2 fire rating 1000 denier «leather look» removable PVC covers and phtalate free. Hook-and-loop bib (on top) to eliminate joints.

**REF. 1780** - Set of FIG mats for safety area for one trampoline  
Made up of 4 REF. 1611, 8 REF. 1617 and 2 REF. 1618.

**REF. 1785** - Set of FIG mats for safety area for 2 trampolines  
Made up of 6 REF. 1611, 13 REF. 1617, 4 REF. 1618 and 1 REF. 1660.

**REF. 1790** - Set of FIG mats for safety area for 4 trampolines  
Made up of 9 REF. 1611, 24 REF. 1617, 4 REF. 1618 and 3 REF. 1660.

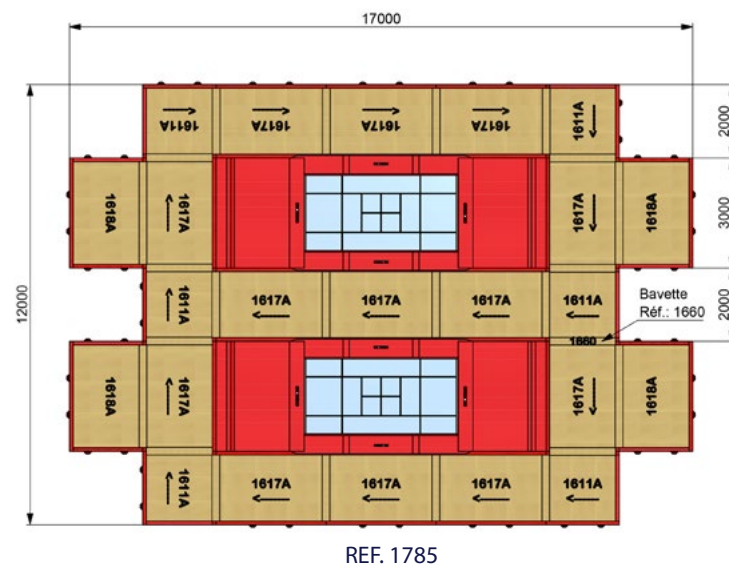

*Please contact us to discuss your safety area made with 20 cm foam or inflatable mats.*

## BUILT-IN TRAMPOLINES



## BUILT-IN TRAMPOLINES

Specially designed for learning the acrobatic figures used in gymnastics. Metal plates anchored over the entire perimeter in the floor to receive the springs. Supplied with peripheral protection pads, 4 cm thick.

*Concrete dimensions and reservation, please consult us.*

**REF. 5351**  
Large size with 13 x 13 mm mesh bed.  
Bed dim. = 426 x 213 cm.

**REF. 5352**  
Identical to Ref. 5351, with pit link.

**REF. 5356**  
Small size with 13 x 13 mm mesh bed.  
Bed dim. = 366 x 183 cm.

**REF. 5357**  
Identical to Ref. 5356, with pit link.

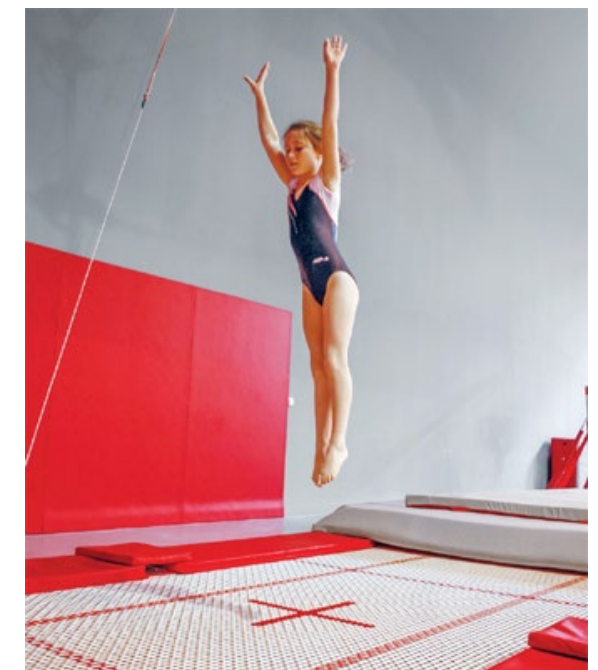



## INITIATION TRAMPOLINES



REF. 5080

### SALTO TRAMPOLINE

#### REF. 5080

Initiation trampoline ideally suited to young gymnasts, school use and leisure activities. Rigid struts and holding cables for a better frame stability. Folding feet for low-space storage.

#### TECHNICAL FEATURES

- Self-assembly frame 374 x 235 cm,
- Height 80 cm,
- 86 cylindrical tempered steel springs
- 3 cm thick protection pads included,
- «Special outdoor» Sportex coated PVC webbing jumping bed 290 x 150 cm for improved durability.

#### ACCESSORIES

**REF. 5082** - Jumping bed. Sportex coated PVC. Dim. = 290 x 150 cm.

**REF. 5084** - Set of 86 springs.

**REF. 5086** - Complete peripheral protection pad. Set of 4.



## TRAMPETTES



REF. 5066

### TEAM-GYM TRAMPETTES

#### Acrobatic power and performance!

Designed for learning and practicing jumping exercises, this trampoline gives gymnasts a major power boost while still enabling them to work safely on their exercises.

It is easy to transport thanks to its integrated castors and is height adjustable from 65 to 80 cm in increments of 5 cm in accordance with UEG requirements.

#### TECHNICAL FEATURES

- Full 4 cm thick peripheral protection including detachable front and rear guards,
- Galvanized springs on 6 x 6 mm mesh bed,
- Frame dim.: 124 x 124 cm,
- Weight: 75 kg.

#### AVAILABLE MODELS

##### REF. 5066 - «Hard» Team-Gym trampette

Aimed more at the larger build. Distinguishing mark: white dot on the peripheral protection. With 40 springs.

##### REF. 5067 - «Soft» Team-Gym trampette

Aimed more at the lighter build. With 36 springs.



With rear guard. Ref. 5068 in option

#### ACCESSORIES

**REF. 5068** - Rear guard.

**REF. 5069** - «Hard» model peripheral protection.

**REF. 5071** - «Soft» model peripheral protection.

**REF. 5072** - Set of 40 springs.

**REF. 5073** - Spare 6 x 6 mm mesh bed.

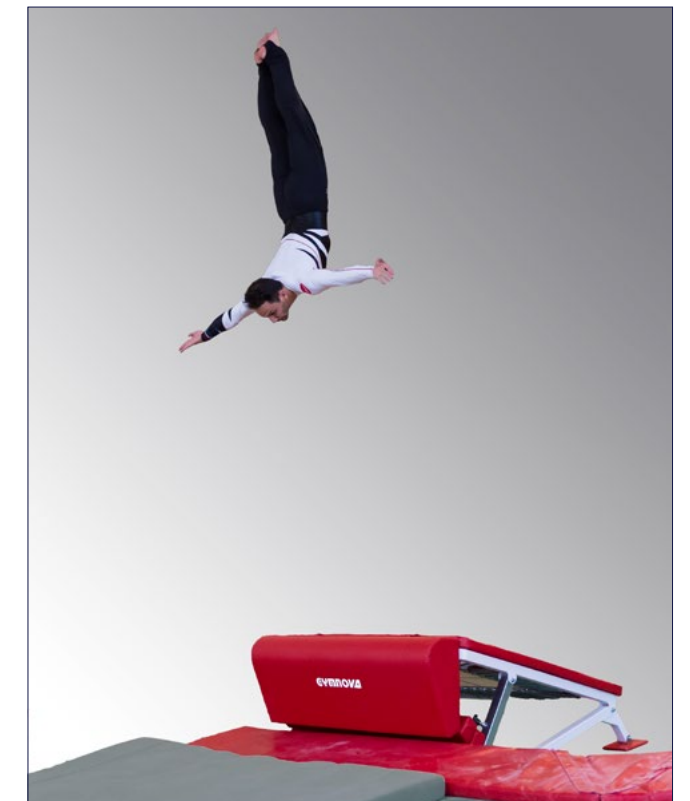



**TRAMPETTES**



**OPEN TRAMPETTE**

**REF. 5052**

Adjustable, multipurpose and dynamic trampette allowing you to work on the most difficult jumps thanks to its entry and exit zone. Folding angle-adjustable legs. Height adjustment of the front section between 35.5 and 37.5 cm. Supplied with side pads and optional front/rear guards.

**TECHNICAL FEATURES**

- 120 x 120 cm tubular frame,
- 32 mm thick protection pads included,
- 13 x 13 mm mesh bed,
- Tension provided by 32 springs,
- Weight: 38,5 kg.

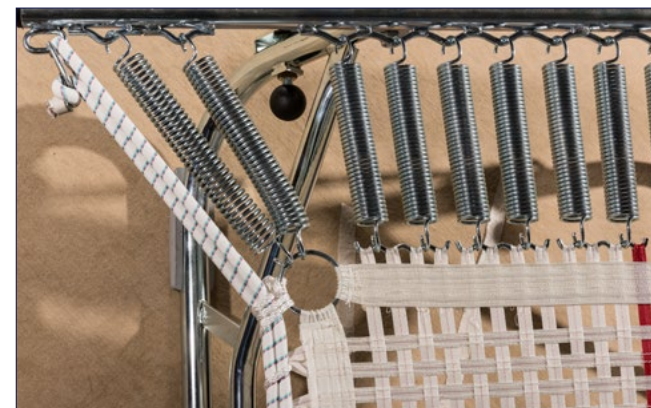

Tension provided by 32 springs

**ACCESSORIES**

- REF. 5043** - Set of front/rear guards.
- REF. 5044** - Set of side pads.
- REF. 5045** - Set of 32 springs.
- REF. 5048** - Spare 13 x 13 mm mesh bed.



REF. 5052 with side pads and optional front/rear guards.

**TRAMPETTES**

**BUNGEE TRAMPETTE**

**REF. 5000** - Sportex coated PVC web bed. Tightened by bungee cords.

**SPRING TRAMPETTE**

**REF. 5010** - Sportex coated PVC web bed. Tightened by 28 steel springs.

**SUPER SPRING TRAMPETTE**

**REF. 5050** - High performance model, identical to Ref. 5010 but with 13 x 13 mm nylon mesh bed. Tightened by 32 springs



REF. 5000

**TECHNICAL FEATURES**

- 113 x 113 cm tubular frame,
- Foldable and adjustable feet from 33 to 54 cm,
- 32 mm thick peripheral protection pad,
- 65 x 65 cm jumping bed,
- Integrated castors,
- Non-slip pads,
- Weight: 33 kg.



Tightened by bungee cords



Tightened by springs

**ACCESSORIES**

**REF. 5020**

Set of spare bungee cords.



**REF. 5030**

Spare Sportex bed.

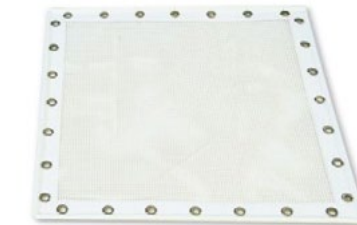

**REF. 5035**

Set of 4 rubber feet.



**REF. 5040**

Full set of guards 116 x 116 cm.



**REF. 5055**

13 x 13 mm nylon mesh bed.



**REF. 5065**

Set of 32 springs.





## TRAMPETTES



SCAN ME

### TRAMPO-TREMP

**REF. 5090** - Halfway between a springboard and a mini-trampoline, the trampo-tremp has been developed specially for all learning and working skills of vaulting exercises. It allows the gymnasts to work repeatedly and comfortably the vault bases to then be able to use a classical springboard. Close to a standard springboard, mean gymnasts do not need to change their run-up or last take-off point. Easily adjustable in height with 3 different positions: 26, 30 and 34 cm.

#### TECHNICAL FEATURES

- Dimensions: 120 x 98 cm (Lxw),
- Reinforced push off bed in PVC (47 x 74 cm) with central cross marking, tightened by 34 springs,
- 3 cm thick peripheral protection pad,
- Integrated castors,
- Non-slip pads,
- Weight: 27 kg.

#### ACCESSORIES

- REF. 5091** - Spare SPORTEX bed.
- REF. 5092** - Complete protection pad.
- REF. 5093** - Set of 34 springs.



Transport wheels

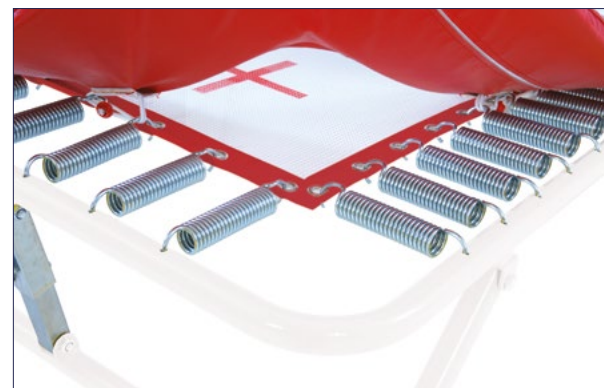

34 galvanized springs connected to the PVC bed

## LONG TRAMPOLINES

### ACROTRAMP

Very effective training aid, helps with learning the technical aspects of acrobatics. Intermediate stage between trampolining and tumbling, facilitates a training system focusing on rebound. To improve safety, the bars can be retracted at the end of the runway under impact.

#### TECHNICAL FEATURES

- Metal frame with Sportex coated PVC webbing bed attached with springs,
- Bed height = 53 cm,
- Overall height (with frame guards) = 60 cm,
- Frame width = 2.20 m,
- 40 mm thick protection pad,
- Non-slip pads.



Built-in Acrotramp, please contact us.

**REF. 5360** - Long trampoline. L = 6.70 m.

**REF. 5361** - Long trampoline. L = 12.70 m.

**REF. 5363** - Long trampoline. L = 18.70 m.

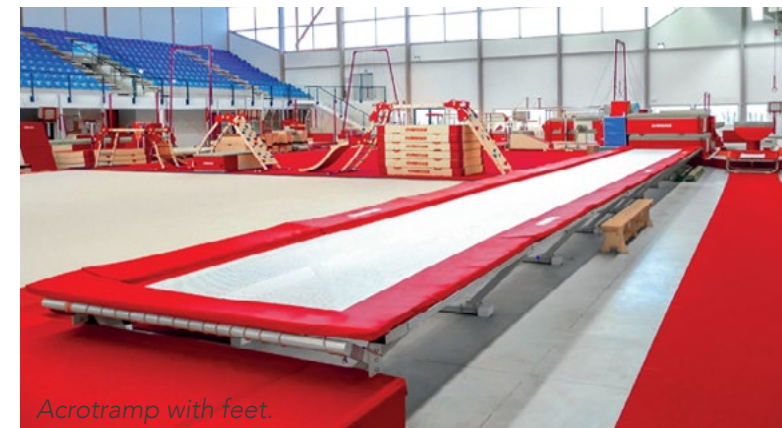

Acrotramp with feet.

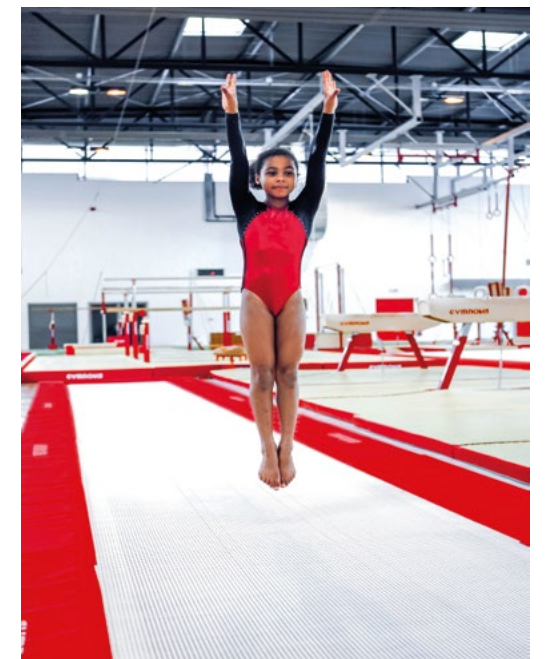



**TUMBLING**

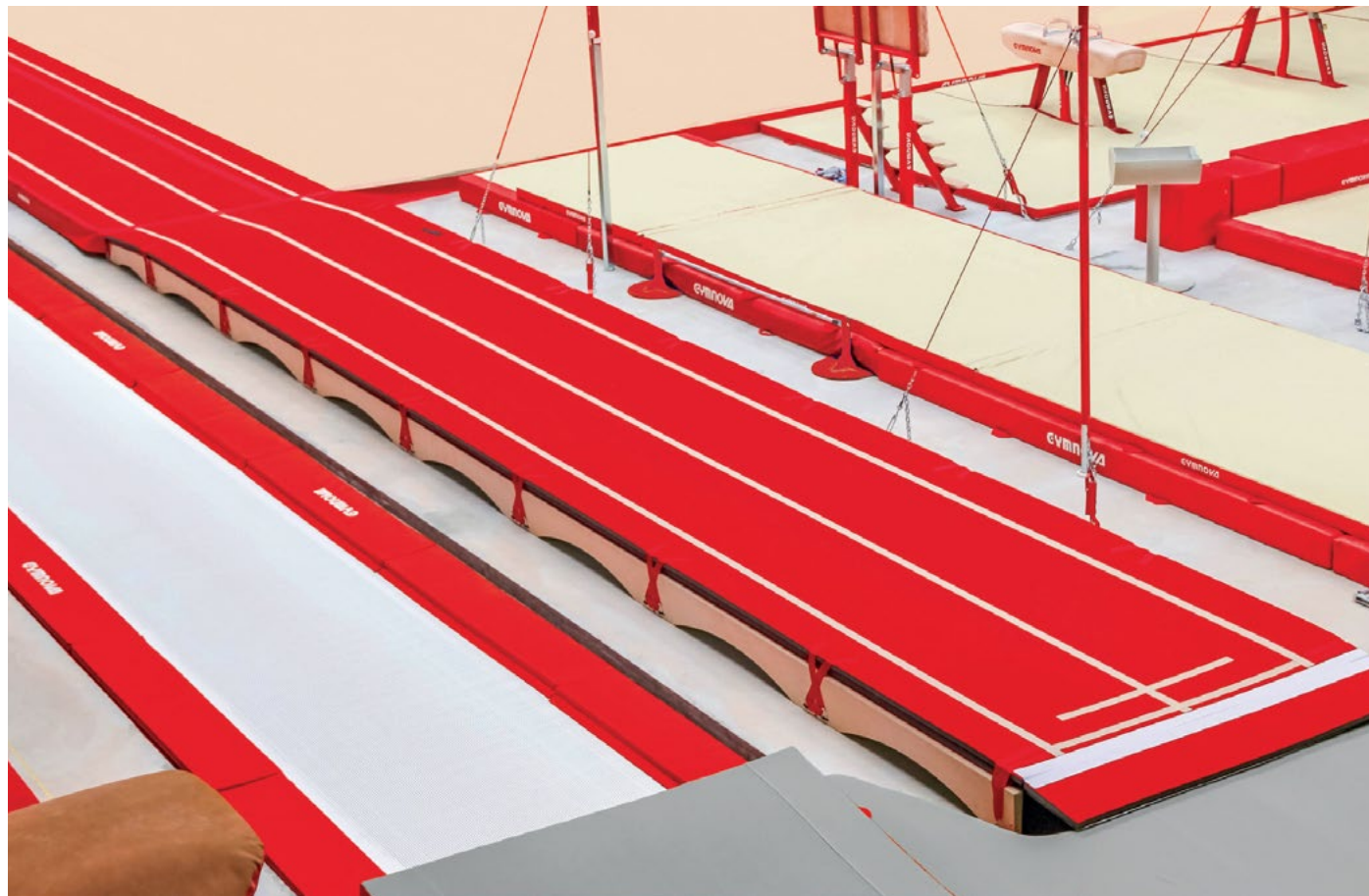

**NOVATRACK'ONE TUMBLING TRACK**



**REF. 6296 - COMPLETE TUMBLE TRACK**

**BOUNCY, COMFORTABLE, SILENT, STABLE...**

This fiberglass track provides a dynamic rebound that will allow the development of complex technical skills.

Tumbling track (dim.: 25.50 x 2 m) with a run-up track (dim.: 10.50 x 1 m) and a landing area (dim.: 6 x 3 m) for a safe landing of the tumbler.

Comfort of use thanks to its 5 mm needed-pile carpet on a 33 mm thick double density PE foam.

**TRACK COMPOSITION**

- 1** REF. 6297 - Run-up track only.
- 2** REF. 6298 - Tumbling track only.
- 3** REF. 6299 - Landing area only.
- 4** REF. 6295 - Additional mat only (optional).

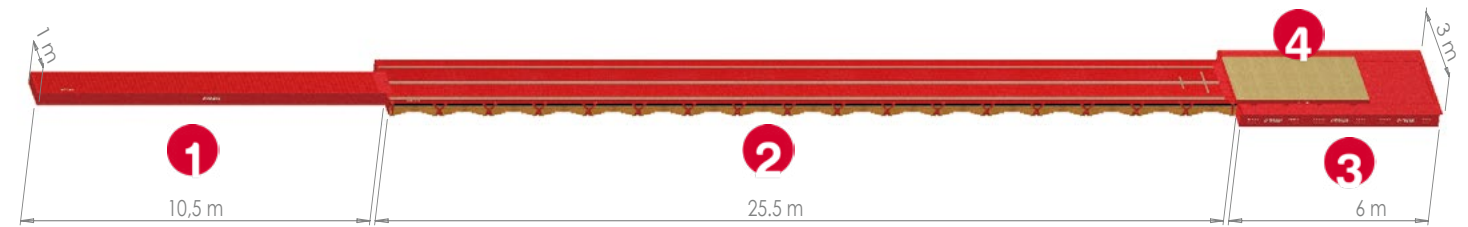

**1 RUN-UP TRACK ONLY**

**Ref. 6297**

Composed of 7 wooden plates with metal legs of 1.50 x 1.00 m on which is placed a monobloc foam track of 10.5 x 1.00 m and 2.5 cm thick. Junction of the plates connected by hook and loop fastener. Side skirt on the perimeter. Link with track through dedicated flap. Dimensions: 1050 x 100 x 2,5 cm (Lxwxth.)



**2 TUMBLING TRACK ONLY**

**Ref. 6298**

Track made up of 17 elements measuring 150 x 200 x 22 cm. Each element contains 2 uprights and 15 fiberglass brushes. Secured by self-gripping bands and metal pins. Dimensions: 2550 x 200 x 22 cm (Lxwxth.)



**3 LANDING AREA ONLY**

**Ref. 6299**

Composed of 3 bi-density mats for a more stable, safe and comfortable landing. Junction of the mats connected by hook and loop fastener and landing area marked with hook and loop fastener. 1,000 denier PVC cover with M2 fire rating, phthalate-free. Link with track through dedicated strap and flap. Dimensions: 600 x 300 x 30 cm (Lxwxth.)

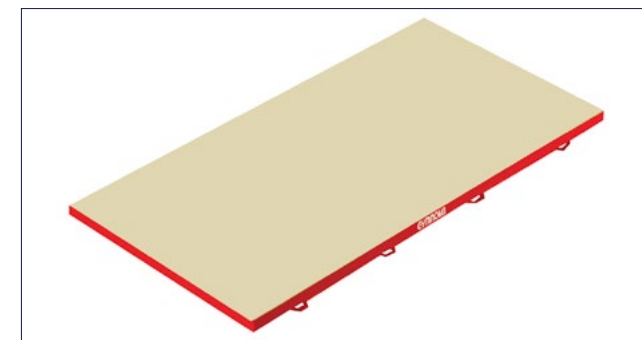

**4 ADDITIONAL MAT ONLY**

**Ref. 6295**

Increase comfort while training. 1,000 denier PVC cover with M2 fire rating, phthalate-free. Junction to the landing area connected by hook and loop fastener. Anti-slip underside. Dimensions: 400 x 200 x 10 cm (Lxwxth.)

*Not included with ref. 6296 et 6299 ; Please, consult us.*



## INFLATABLE TRACKS

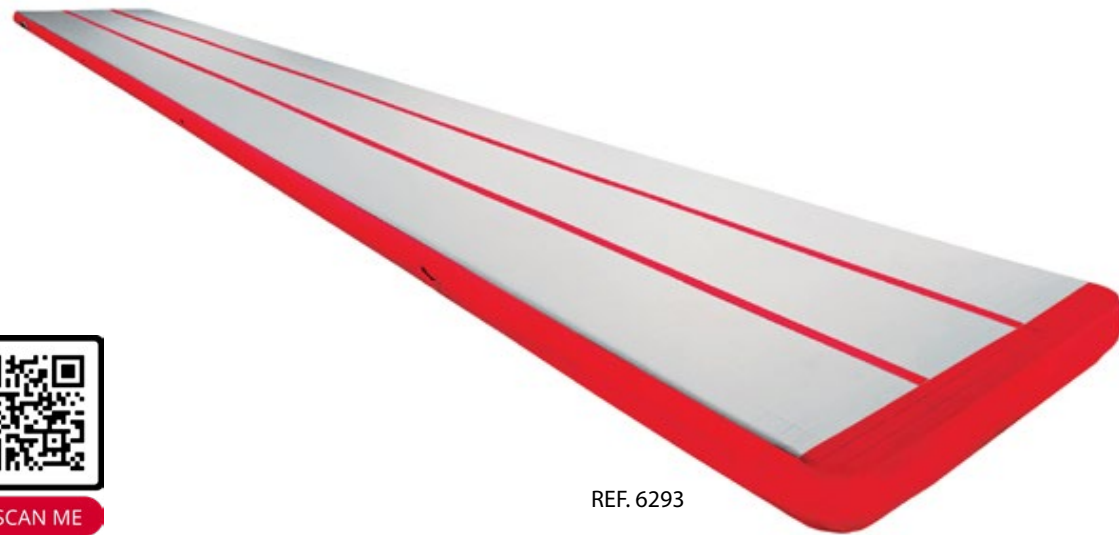

REF. 6293

Allow various assembly combinations to perform acrobatics on a flat working surface while ensuring stability and precision during push-offs. Safe, the tracks are ideal for acrobatics while limiting ankles and wrists' injuries caused by repetitive exercises.

Self-contained, tracks stay inflated for the entire duration of your daily practices, without having to use the inflator. Easy to handle, it is convenient for all type and level of gymnasts from beginners to elite (the firmness of the track can be adjusted according to the weight of the users and the difficulty of the exercises). Easy and quick to set-up and repack.

### REF. 6291 - INFLATABLE TRACK 12 M

Dimensions: 1200 x 180 x 15 cm (Lxwxth.). Weight: 75 kg. Supplied with 1 inflator, a pressure gauge, a repair kit and a transport cover. 4 carrying handles, 2 valves and hook-and-loop strips across both widths.

### REF. 6293 - INFLATABLE TRACK 15 M

Dimensions: 1500 x 210 x 20 cm (Lxwxth.). Weight: 107 kg. Supplied with 2 inflators, a pressure gauge, a repair kit and a transport cover. 8 carrying handles, 3 valves and hook-and-loop strips across both widths.

### REF. 6310 - INFLATABLE TRACK 10 M

Dimensions: 1000 x 140 x 10 cm (Lxwxth.). Weight: 42 kg. With 2 valves and self-fixing strips across the 2 widths. It is used more on a surface such as an exercise floor. Comprising 1 inflator, a pressure gauge, a repair kit and a transport cover.

Optional trolley.

Power requirements: 220 volts. Other power, please contact us.

**Please contact us for made-to-measure inflatable tracks.**

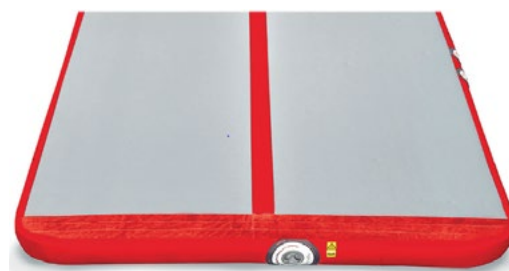

Hook-and-loop strips across both widths



Inflation valve



Digital pressure gauge

## ACCESSORIES

### CHALK BOWLS

#### REF. 2860 - GVA CHALK BOWL

Lightweight, with carrying handle. Facility for the gymnast to attach accessories (sprays, etc.). The half-sphere shaped container reduces chalk dispersal. H = 82 cm.

#### REF. 2861 - CHALK TRAY FOR FEET

Ideal for tumbling. Built-in carpet within frame. In polycarbonate. Inside dim. = 40 x 60 cm.

#### REF. 2862 - STANDARD CHALK BOWL

On a pedestal, with wooden stand. H = 75 cm.

### CHALK

REF. 2850 - 3 packs of 8 x 50 g blocks.

REF. 2870 - 36 packs of 8 x 50 g blocks.

REF. 2852 - Chalk cream - Unit.

REF. 2853 - Chalk cream - Set of 12 bottles.

REF. 2854 - Chalk cream - Set of 48 bottles.



REF. 2860



REF. 2862



REF. 2852



REF. 2861

### ROLL-UP TUMBLING TRACK

#### REF. 6160

Track made up of needled-pile carpet (bonded) on a class M4 fire rated dynamic foam. These tracks can be joined together to make up larger tumbling surfaces. They are joined together with hook-and-loop strips that attach directly to the carpet. They roll up, which makes them easy to store. Non-slip underside. Dim. = 1400 x 200 x 4 cm (Lxwxth).



REF. 6160

### COMPETITION SPRINGBOARDS

Designed for intensive use, these competition springboards allow exercises to be repeated while minimising premature gymnast fatigue. Standardised 120 x 60 cm size board in curved plywood and fibreglass covered in carpet. Height = 23 cm. Carrying handles incorporated in the frame. Non-slip pads.

#### REF. 2186 - EVOLUTION SPRINGBOARD «HARD»

Aimed more at the larger build (50 -100 kg). Distinguishing mark: red dot on the board. With 8 springs. Weight: 25 kg.

#### REF. 2187 - EVOLUTION SPRINGBOARD «SOFT»

Aimed more at the lighter build (40 -75 kg). With 5 springs. Weight: 23 kg.

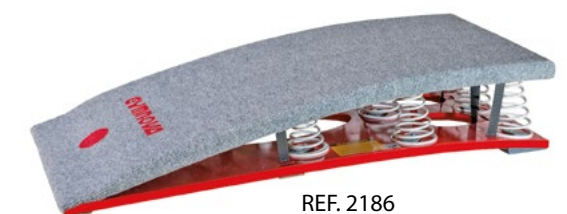

REF. 2186

**ACCESSORIES**

**HARNES BELTS**

**REF. 2830**

Belt with bearings to learn forward and backward rotations. One size fits all, adjustable on a child (from 5 years old) as well as an adult. Equipped with a safety buckle, this belt is adjustable from 55 to 112 cm. The landmarks (from 1 to 6) allow to refine the adjustment of the belt. The backrest is made of tissue anti-transpiration technology.

*Compliant with the resistance standard EN-358: 1999.*

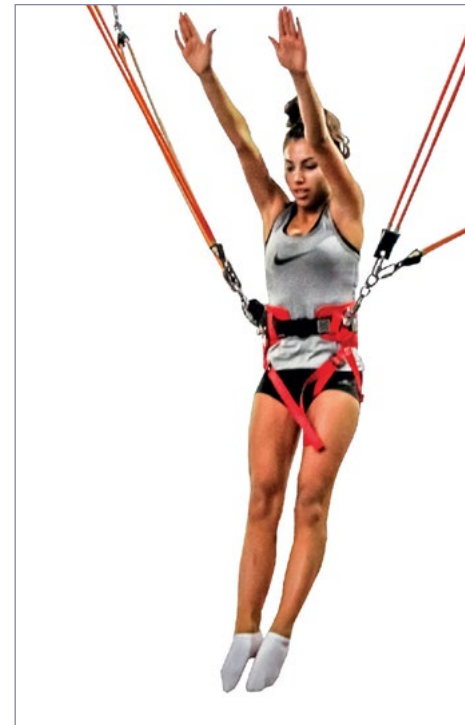

**TWISTING BELTS**

Belts with ball bearings for performing exercises with twists. Quick and easy to close. Supplied with legs straps.

**REF. 2790 - Large model twisting belt**  
 Ø = 38 cm. Waist size from 80 to 110 cm.

**REF. 2795 - Small model twisting belt**  
 Ø = 30 cm. Waist size from 55 to 80 cm.

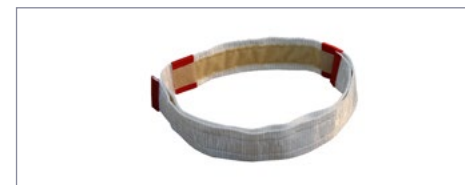

**SAFETY BELT**

**REF. 2840**

Adjustable belt with hooks for attaching long or short lanyards. Fits all waist sizes.

**LANYARDS**

**REF. 2810**

Spotting lanyards with swivel pins for direct operation by the coach during acrobatics. L: 1.50 m. The pair.

*Lanyards attached to frame, fixed or mobile. Study on request, please contact us.*



**INDEX**

**B**  
 Beds .....8,13,14,15,16  
 Belts .....26  
 Built-in trampolines .....12

**C**  
 Castors .....10  
 Chalk .....25  
 Chalk bowls .....22  
 Competition springboards.....22  
 Competition trampolines.....5,6

**E**  
 End decks .....8

**I**  
 Inflatable tracks .....24

**L**  
 Lanyards .....26  
 Long trampolines .....18

**M**  
 Mats .....7,8

**O**  
 Open trampette .....18

**P**  
 Protections .....10,14,15,16

**R**  
 Roll-up tumbling track.....25

**S**  
 Safety area .....14  
 Springs .....10,14,15,16

**T**  
 Team Gym trampolines .....16  
 Training trampolines .....13  
 Trampettes .....19  
 Trampo-tremp .....17  
 Tumbling track .....22

**OTHER BROCHURES**

**GYMNOVA CATALOGUE**

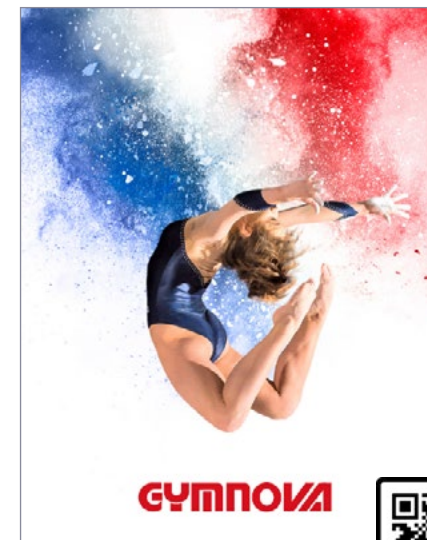

SCAN ME

**EDUC'GYM CATALOGUE**



SCAN ME

**Find our general terms of sale and our assembly instructions on our website [www.gymnova.com](http://www.gymnova.com).**

*The photos in this catalogue are not contractually binding.  
 Design and layout: GYMNOVA  
 Edition: January 2021*





## GYMNOVA, OFFICIAL SUPPLIER OF THE FOLLOWING COMPETITIONS

### 2019

- Acrobatics European Championships, Holon (Israel)
- Aerobic FIG World Cup, Cantanhede (Portugal)
- Gymnastics World Cup, UK

### 2018

- Artistic Gymnastics European Championships, Glasgow (Scotland)
- Aerobic World Championships, Guimaraes (Portugal)
- Rhythmic Gymnastics European Championships, Guadalajara (Spain)

### 2017

- Artistic Gymnastics World Championships, Montreal (Canada)
- Acrobatic Gymnastics World Cup, Paris (France)
- Mediterranean Games, Tarragone (Spain)
- World Cup, London (UK)

### 2016

- Olympic Games, Rio (Brazil)
- Rythmic Gymnastics European Championships, Holon (Israel)
- Aerobic World Championships, Incheon (Korea)
- Test-Event, Rio (Brazil)

*Complete list upon request*

# GYMNOVA

CS 30056 - 45 RUE GASTON DE FLOTTE - 13375 MARSEILLE CEDEX 12 - FRANCE  
TEL. +33 (0)4 91 87 51 20

[export@gymnova.com](mailto:export@gymnova.com) - [WWW.GYMNOVA.COM](http://WWW.GYMNOVA.COM)

une société d' **ABEO** 